

---

# BASIC OF ELECTRONICS

Pavol Galajda, KEMT, FEI, TUKE  
Pavol.Galajda@tuke.sk

# Field-Effect Transistor (FET)

---

## Introduction

- **4.1 Field- Effect Transistor Amplifiers**
- **4.2 Advantage and Disadvantage of the FET**
- **4.3 Types of FETs**
- **4.4 JFET Operation and Construction**

# Introduction

The performance of the *field-effect transistor (FET)*, which was proposed by W. Shockley in 1952, is different from that of the BJT. The controlling parameter for an FET is *voltage* instead of *current*.

The FET is a *unipolar* device, since current exists *either* as electrons or holes. In an *n*-channel FET, electron current exists, and in a *p*-channel FET, hole current exists. Both types of FET are controlled by a voltage imposed between the *gate* and the *source*.

In comparing FETs to BJTs, we notice that the *drain (D)* is analogous to the collector and the *source (S)* is analogous to the emitter. A third contact, the *gate (G)*, is analogous to the base. The source and drain of an FET can usually be interchanged without affecting transistor operation.

# Introduction

This chapter begins with a discussion of the FET characteristics and a comparison of these characteristics with the characteristics of the BJT. The construction and operation of both JFETs and MOSFETs are then described. We develop the biasing techniques for FETs followed by ac analysis using equivalent circuits. We then derive the gain equations for the common-source (CS) amplifier. This is followed by development of a step-by-step design procedure, which is applied to several design examples.

Analysis and design of common-drain (CD) (source follower (SF)) amplifiers are then presented. Step-by-step design procedures are developed followed by application of these procedures to examples.

The chapter concludes with a brief discussion of other speciality devices.

## 4.2 Advantages and Disadvantages of the FET

The advantages of FETs can be summarized as follows:

1. They are voltage-sensitive devices with high input impedance (on the order of  $10^7$  to  $10^{12} \Omega$ ). Since this input impedance is considerably higher than that of BJTs, FETs are preferred over BJTs for use as the input stage to a multistage amplifier.
2. FETs generate a lower noise level than BJTs.
3. FETs are more temperature stable than BJTs.
4. FETs are generally easier to fabricate than BJTs, since they usually require fewer masking steps and fewer diffusions. Greater numbers of devices can be fabricated on a single chip (i.e., increased *packing density* is possible).

## 4.2 Advantages and Disadvantages of the FET

5. FETs react like voltage-controlled variable resistors for small values of drain source voltage.
6. The high input impedance of FETs permit them to store charge long enough to allow use as storage elements.
7. Power FETs can dissipate high power and can switch large currents.

There are several disadvantages that limit the use of FETs in some applications:

1. FETs usually exhibit poor frequency response because of high input capacitance.
2. Some types of FETs exhibit poor linearity.
3. FETs can be damaged in handling due to static electricity.



## 4.3 Type of FETs

We consider here three major types of FETs:

1. Junction FET (JFET)
2. Depletion-mode metal-oxide semiconductor FET (depletion MOSFET)
3. Enhancement-mode metal-oxide semiconductor FET (enhancement MOSFET)

The MOSFET is often called an insulated-gate FET (IGFET).

## 4.3 JFET Operation and Construction

Like the BJT, the FET is a three-terminal device, but it has only one  $pn$  junction rather than two, as in the BJT. A schematic for the physical structure of the JFET is shown in Figure 4.1.

The  $n$ -channel JFET, shown in Figure 4.1(a), is constructed using a strip of  $n$ -type material with two  $p$ -type materials diffused into the strip, one on each side. The  $p$ -channel JFET has a strip of  $p$ -type material with two  $n$ -type materials diffused into the strip, as shown in Figure 4.1(b).

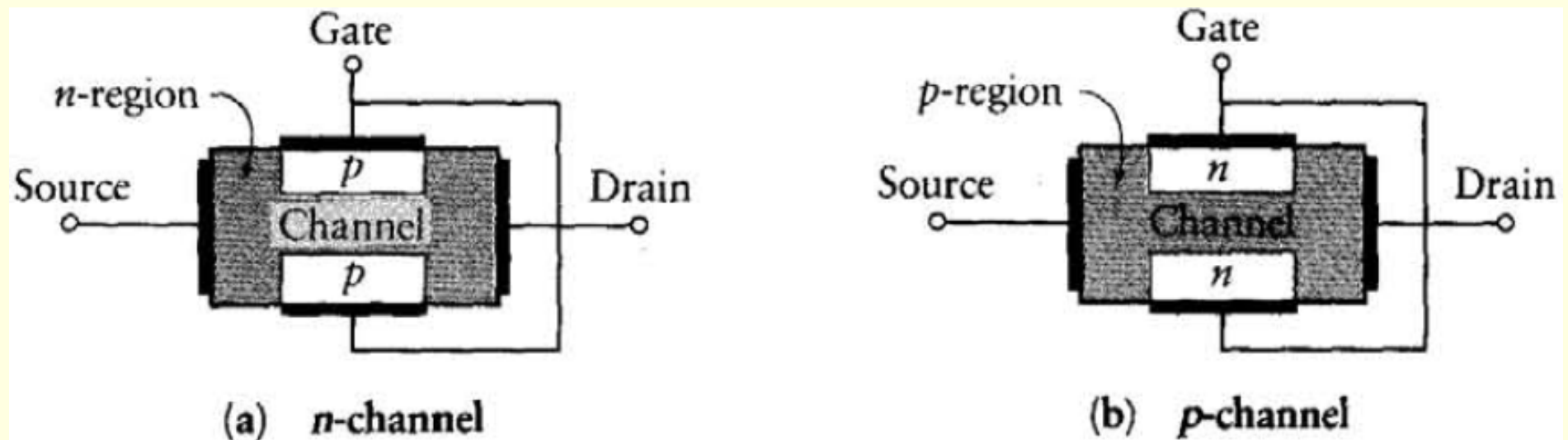



## 4.3 JFET Operation and Construction

To understand the operation of the JFET, we connect the  $n$ -channel JFET of Figure 4.1(a) to an external circuit. A supply voltage,  $V_{DD}$ , is applied to the drain (this is analogous to the  $V_{CC}$  supply voltage for a BJT) and the source is brought to common. A gate supply voltage,  $V_{GG}$ , is applied to the gate (this is analogous to  $V_{BB}$  for the BJT). This circuit configuration is shown in Figure 4.2(a).

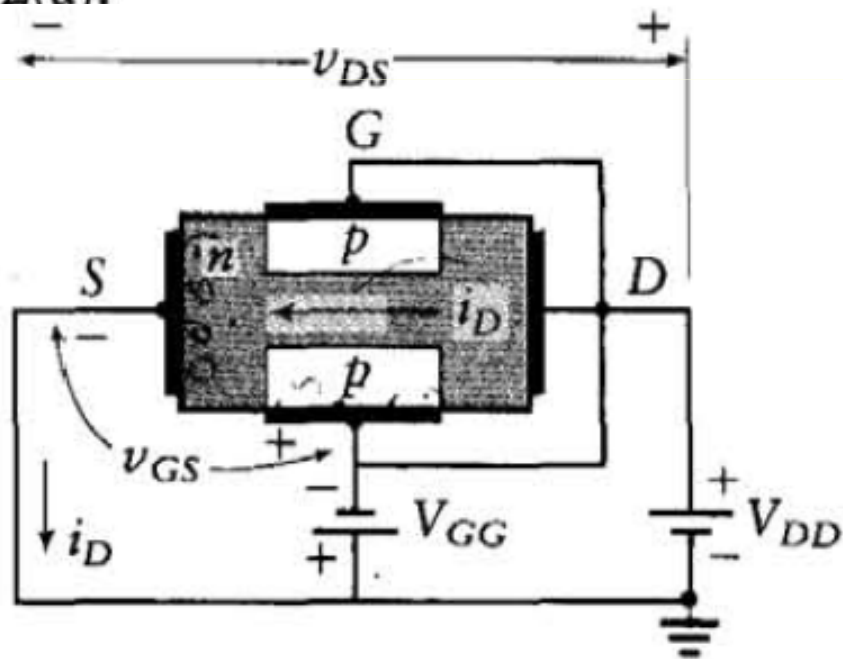

(a)

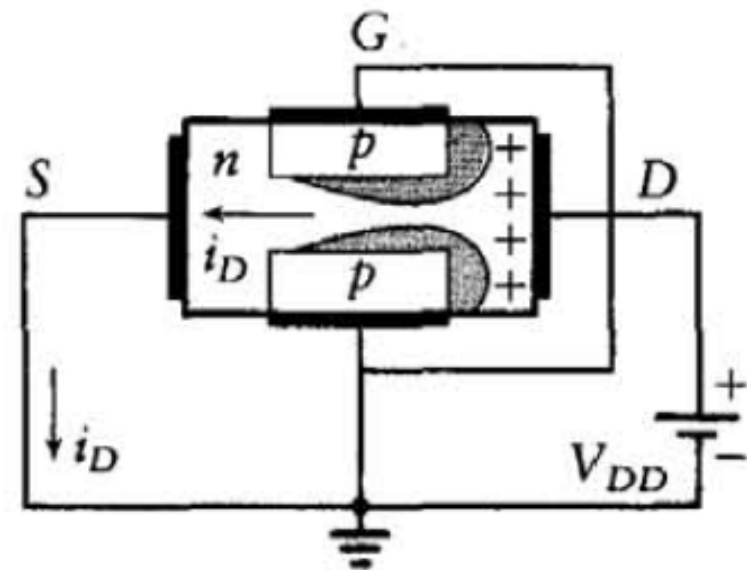

(b)

# 4.3 JFET Operation and Construction

## Construction

$V_{DD}$  provides a drain-source voltage,  $v_{DS}$ , that causes a drain current,  $i_D$ , from drain to source. The drain current,  $i_D$ , which is identical to the source current, exists in the channel surrounded by the  $p$ -type gate. The gate-to-source voltage,  $v_{GS}$ , which is equal to  $-V_{GG}$  (see Figure 4.2(a)), creates a *depletion region* in the channel, which reduces the channel width and hence increases the resistance between drain and source. Since the gate-source junction is reverse-biased, a zero gate current results.

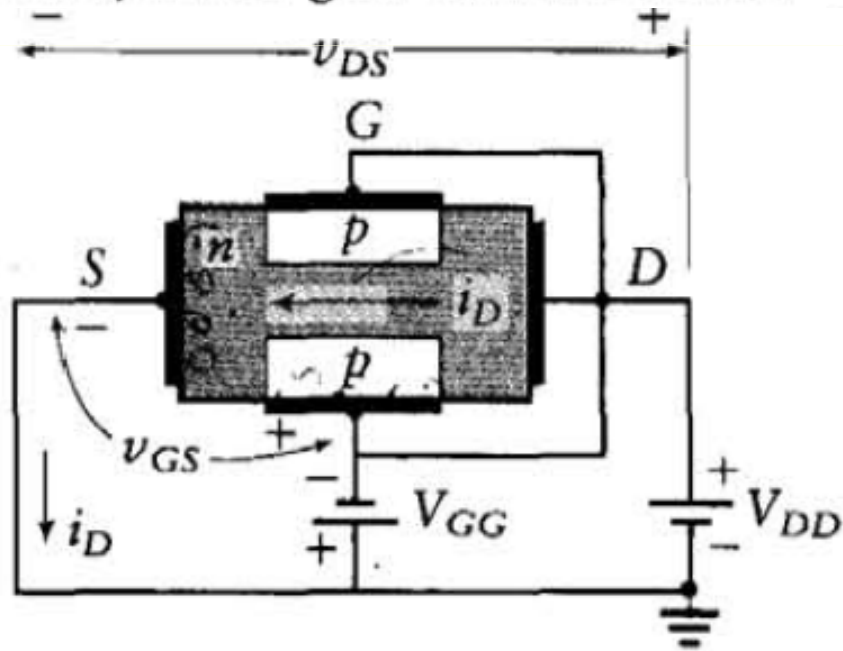

(a)

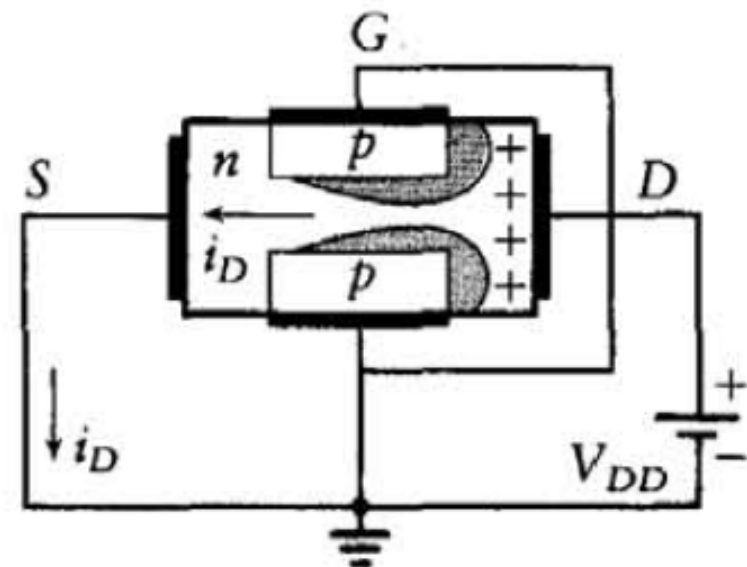

(b)

## 4.3 JFET Operation and Construction

We consider JFET operation with  $v_{GS} = 0$ , as shown in Figure 4.2(b). The drain current,  $i_D$ , through the  $n$ -channel from drain to source causes a voltage drop along the channel, with the higher potential at the drain-gate junction. This positive voltage at the drain-gate junction reverse-biases the  $pn$  junction and produces a depletion region, as shown by the shaded area in Figure 4.2(b).

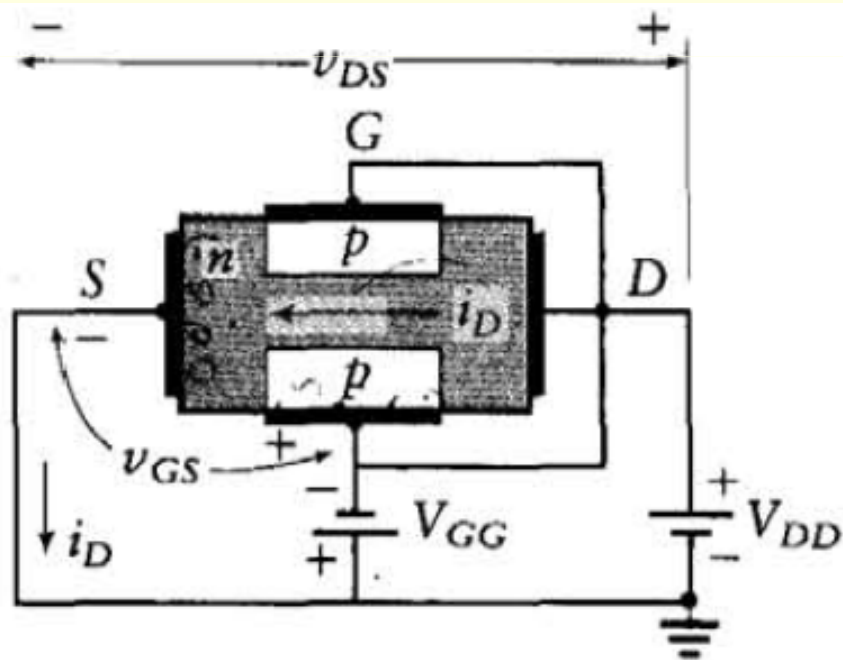

(a)

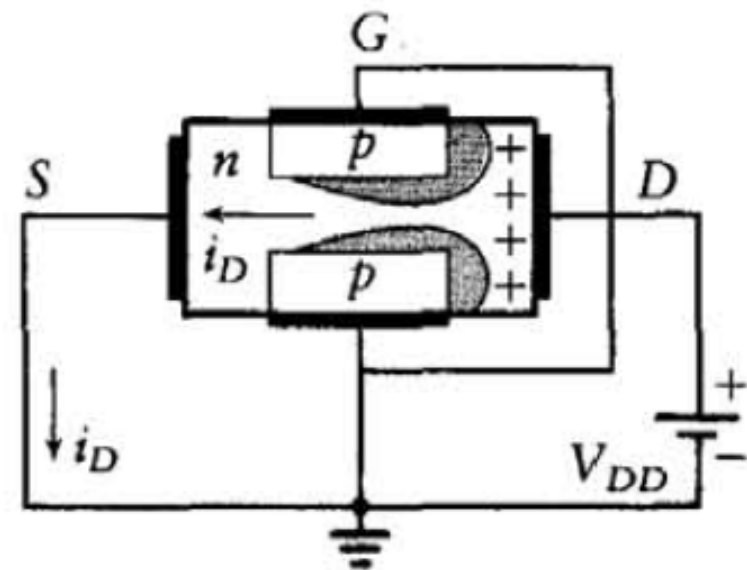

(b)

## 4.3 JFET Operation and Construction

When we increase  $v_{DS}$ , the drain current,  $i_D$ , also increases, as shown in Figure 4.3. This action results in a larger depletion region and an increased channel resistance between drain and source. As  $v_{DS}$  is further increased, a point is reached where the depletion region forms across the entire channel and the drain current reaches its saturation point. If we increase  $v_{DS}$  beyond this point,  $i_D$  remains constant. The value of the saturated drain current with  $V_{GS} = 0$  is an important parameter and is denoted as the *drain-source saturation current*,  $I_{DSS}$ . As can be seen from Figure 4.3, increasing  $v_{DS}$  beyond this channel *pinch-off* point causes no further increase in  $i_D$ , and the  $i_D$ - $v_{DS}$  characteristic curve becomes flat (i.e.,  $i_D$  remains constant as  $v_{DS}$  is further increased).

**Figure 4.3**  
 $i_D$ - $v_{DS}$  characteristic  
for  $n$ -channel JFET.

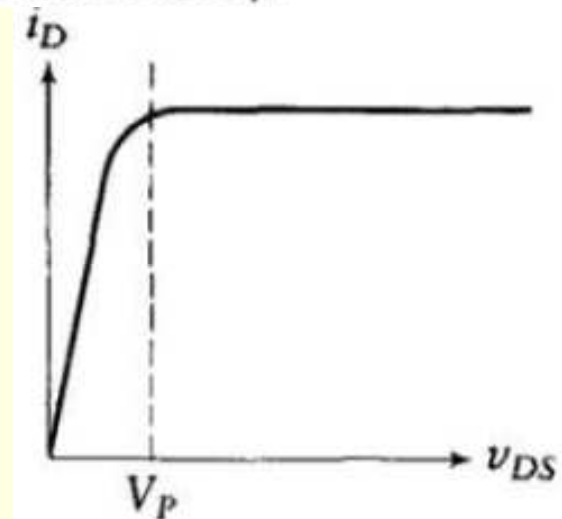



## 4.3.1 JFET Gate-to-Source Voltage Variation

In the previous section, we developed the  $i_D$ - $v_{DS}$  characteristic curve with  $v_{GS} = 0$ . In this section, we consider the complete  $i_D$ - $v_{DS}$  characteristics for various values of the  $v_{GS}$  parameter. Note that in the case of the BJT, the characteristic curves ( $i_C$ - $v_{CE}$ ) have  $i_B$  as the parameter. The FET is a voltage-controlled device and is controlled by  $v_{GS}$ . Figure 4.4 shows the  $i_D$ - $v_{DS}$  characteristic curves for both the  $n$ -channel and  $p$ -channel JFET. Before we discuss these curves, take note of the symbols for an  $n$ -channel and a  $p$ -channel JFET, which are also shown in Figure 4.4. These symbols are the same except for the direction of the arrow.

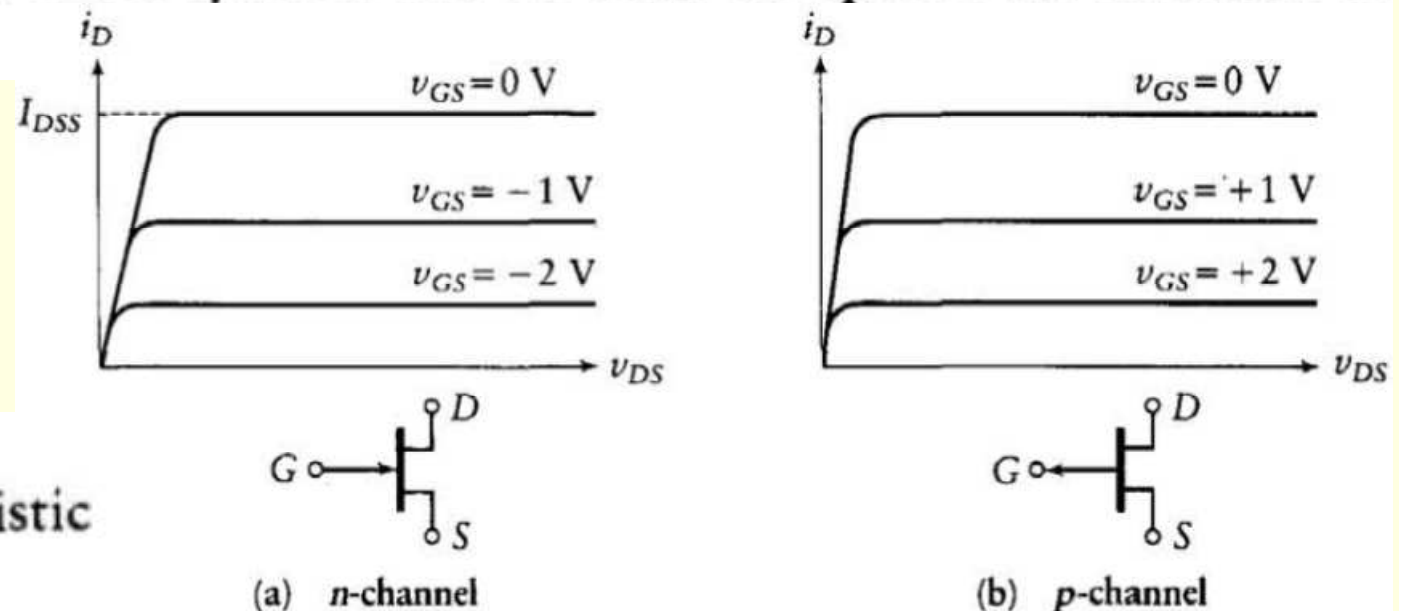

**Figure 4.4**  
 $i_D$ - $v_{DS}$  characteristic  
curves for JFET.

## 4.3.1 JFET Gate-to-Source Voltage Variation

As  $v_{GS}$  is increased (more negative for an  $n$ -channel and more positive for a  $p$ -channel) the depletion region is formed and closes off for a lower value of  $i_D$ . Hence, for the  $n$ -channel JFET of Figure 4.4(a), the maximum  $i_D$  reduces from  $I_{DSS}$  as  $v_{GS}$  is made more negative. If  $v_{GS}$  is further decreased (more negative), a value of  $v_{GS}$  is reached, after which  $i_D$  will be zero regardless of the value of  $v_{DS}$ . This value of  $v_{GS}$  is called  $V_{GS\text{OFF}}$ , or *pinch-off voltage* ( $V_p$ ). The value of  $V_p$  is negative for an  $n$ -channel JFET and positive for a  $p$ -channel JFET.

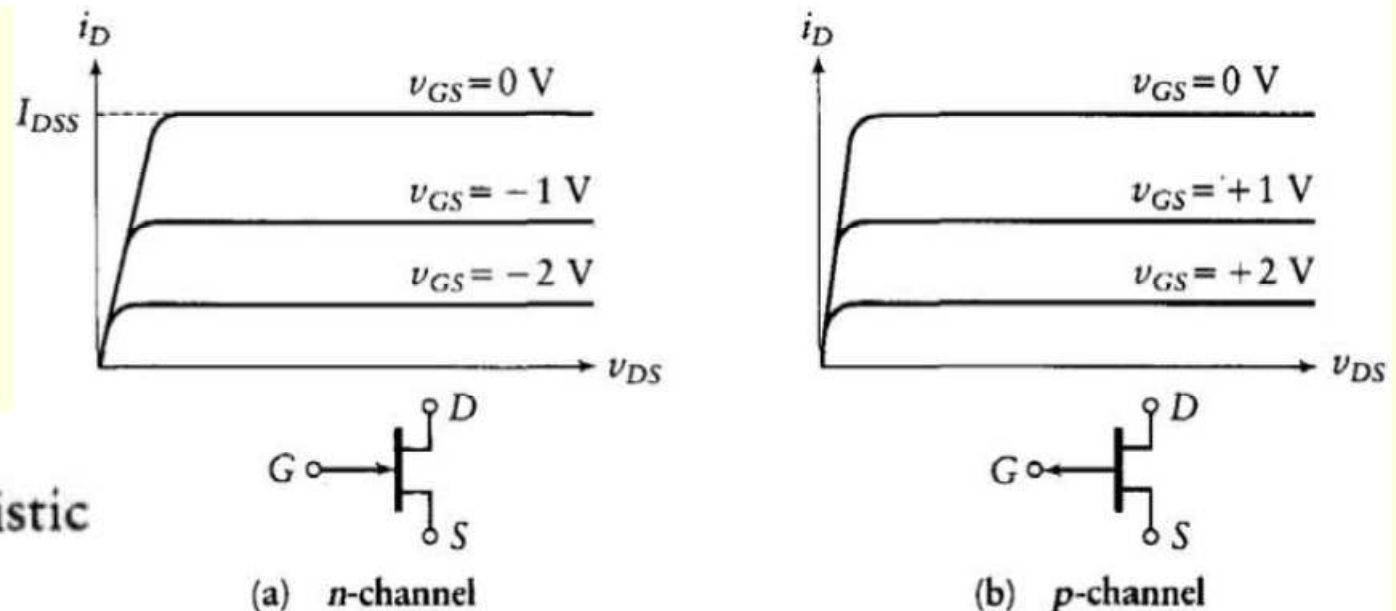
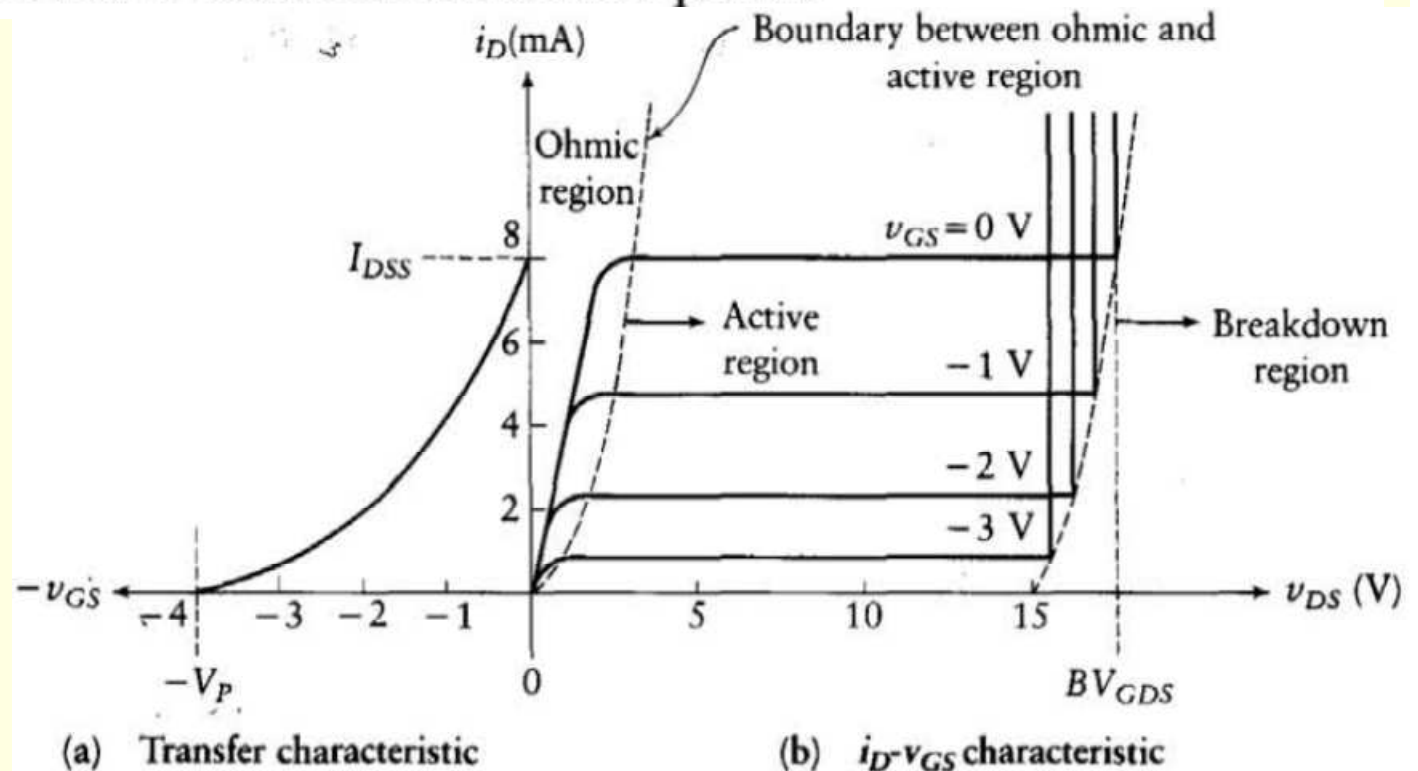

**Figure 4.4**  
 $i_D$ - $v_{DS}$  characteristic  
curves for JFET.



## 4.3.2 JFET Transfer Characteristics

Of great value in JFET design is the transfer characteristic, which is a plot of the drain current,  $i_D$ , as a function of gate-to-source voltage,  $v_{GS}$ , above pinch-off. Although this is plotted with  $v_{DS}$  equal to a constant, the transfer characteristic is essentially independent of  $v_{DS}$  since, after the FET reaches pinch-off,  $i_D$  remains constant for increasing values of  $v_{DS}$ . This can be seen from the  $i_D$ - $v_{DS}$  curves of Figure 4.4, where each curve becomes flat for values of  $v_{DS} > V_p$ . Each curve has a different saturation point.



**Figure 4.5**  
JFET characteristics.

(a) Transfer characteristic

(b)  $i_D$ - $v_{GS}$  characteristic

## 4.3.2 JFET Transfer Characteristics

In Figure 4.5, we show the transfer characteristics and the  $i_D$ - $v_{GS}$  characteristics for an  $n$ -channel JFET. We plot these with a common  $i_D$  axis. The transfer characteristics can be obtained from an extension of the  $i_D$ - $v_{DS}$  curves. A useful method of determining the transfer characteristic is with the following relationship (the Shockley equation):

$$\frac{i_D}{I_{DSS}} \approx \left(1 - \frac{v_{GS}}{V_P}\right)^2 \quad (4.1)$$

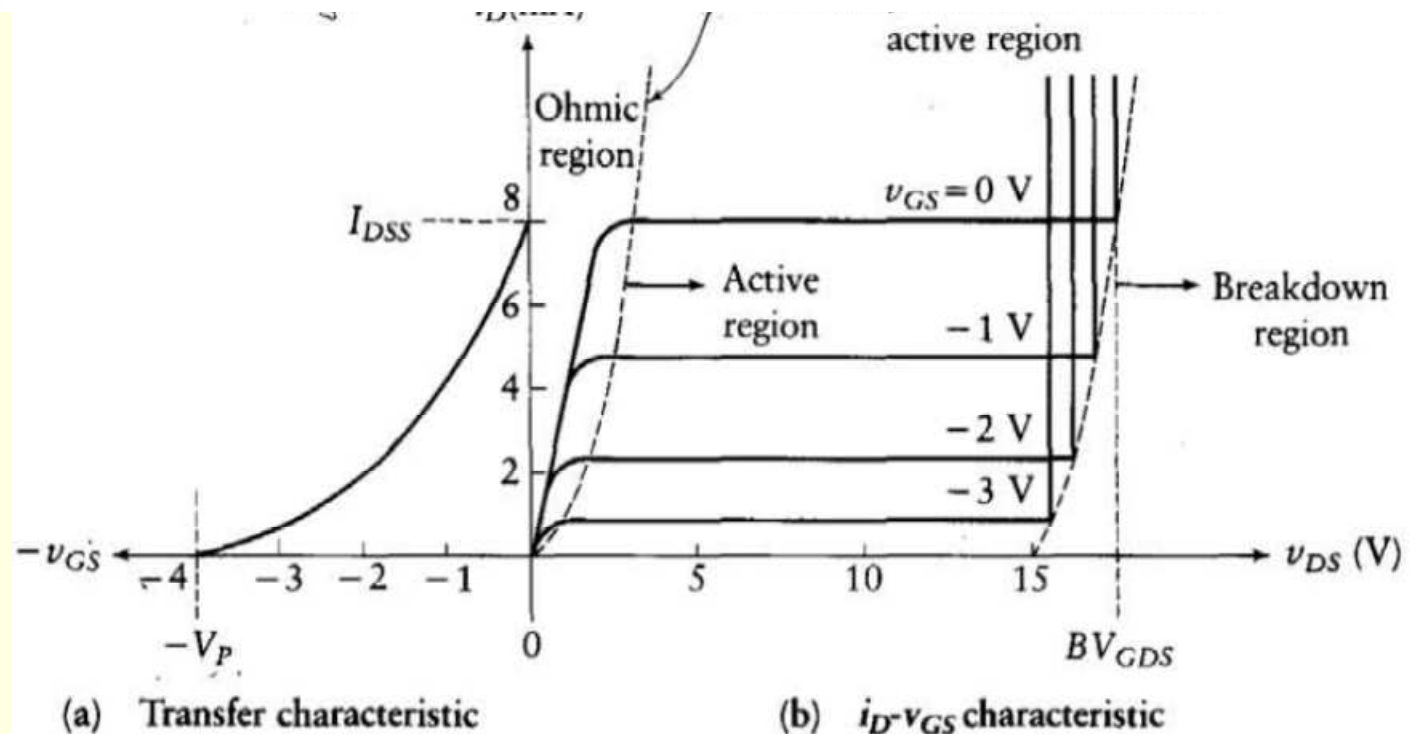
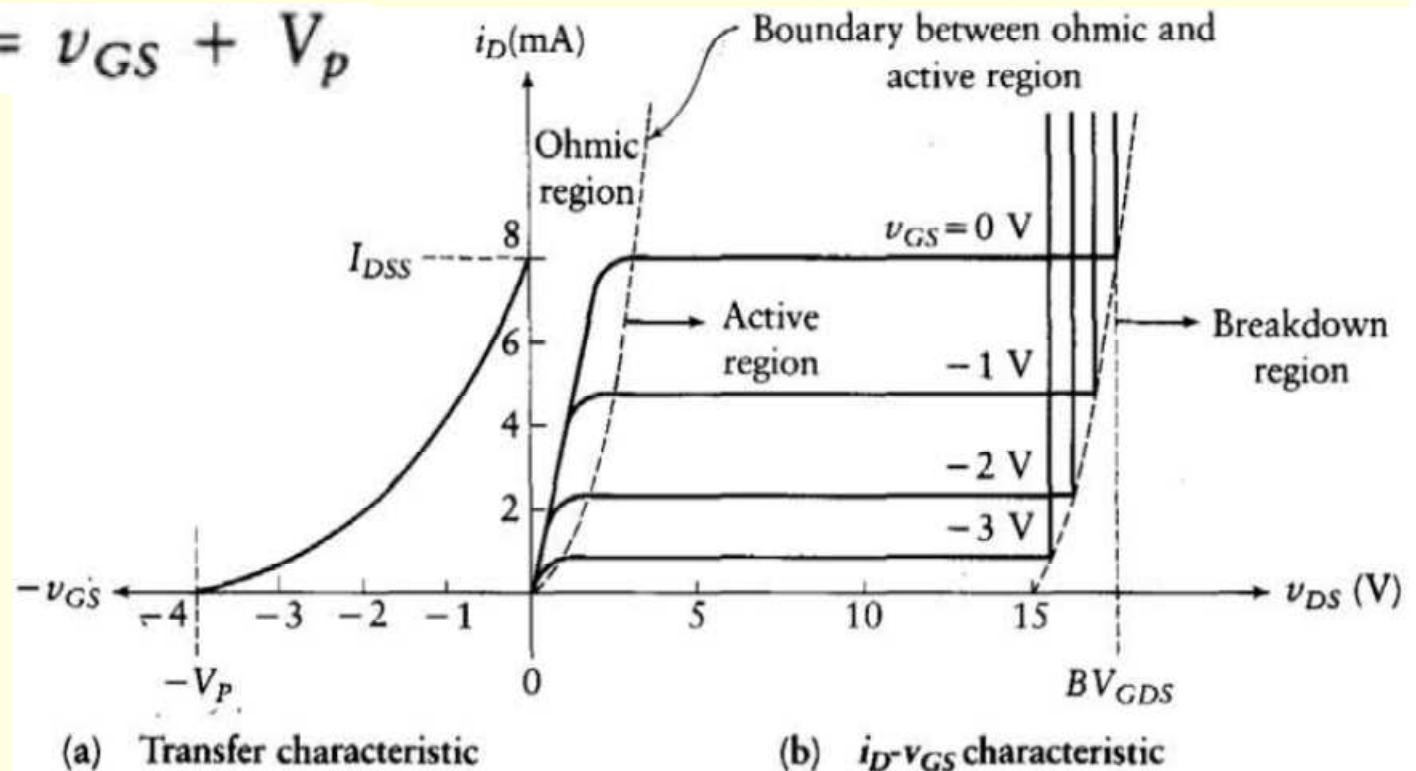

**Figure 4.5**  
JFET characteristics.

## 4.3.2 JFET Transfer Characteristics

Hence, we need to know only  $I_{DSS}$  and  $V_p$ , and the entire characteristic is then determined. Manufacturer's data sheets often give these two parameters, so the transfer characteristic can be constructed or equation (4.1) can be used directly. Note that  $i_D$  saturates (i.e., becomes constant) as  $v_{DS}$  exceeds the voltage necessary for the channel to pinch off. This can be expressed as an equation for  $v_{DS(sat)}$  for each curve, as follows:

$$v_{DS(sat)} = v_{GS} + V_p$$



**Figure 4.5**  
JFET characteristics.

(a) Transfer characteristic

(b)  $i_D$ - $v_{GS}$  characteristic

# 4.3.2 JFET Transfer Characteristics

$$v_{DS(sat)} = v_{GS} + V_p$$

As  $v_{GS}$  becomes more negative, the pinch-off occurs at lower values of  $v_{DS}$  and the saturation current becomes smaller. The useful region for linear operation is above pinch-off and below the breakdown voltage. In this region,  $i_D$  is saturated and its value depends upon  $v_{GS}$ , according to equation (4.1) or the transfer characteristic.

$$\frac{i_D}{I_{DSS}} \approx \left(1 - \frac{v_{GS}}{V_p}\right)^2$$

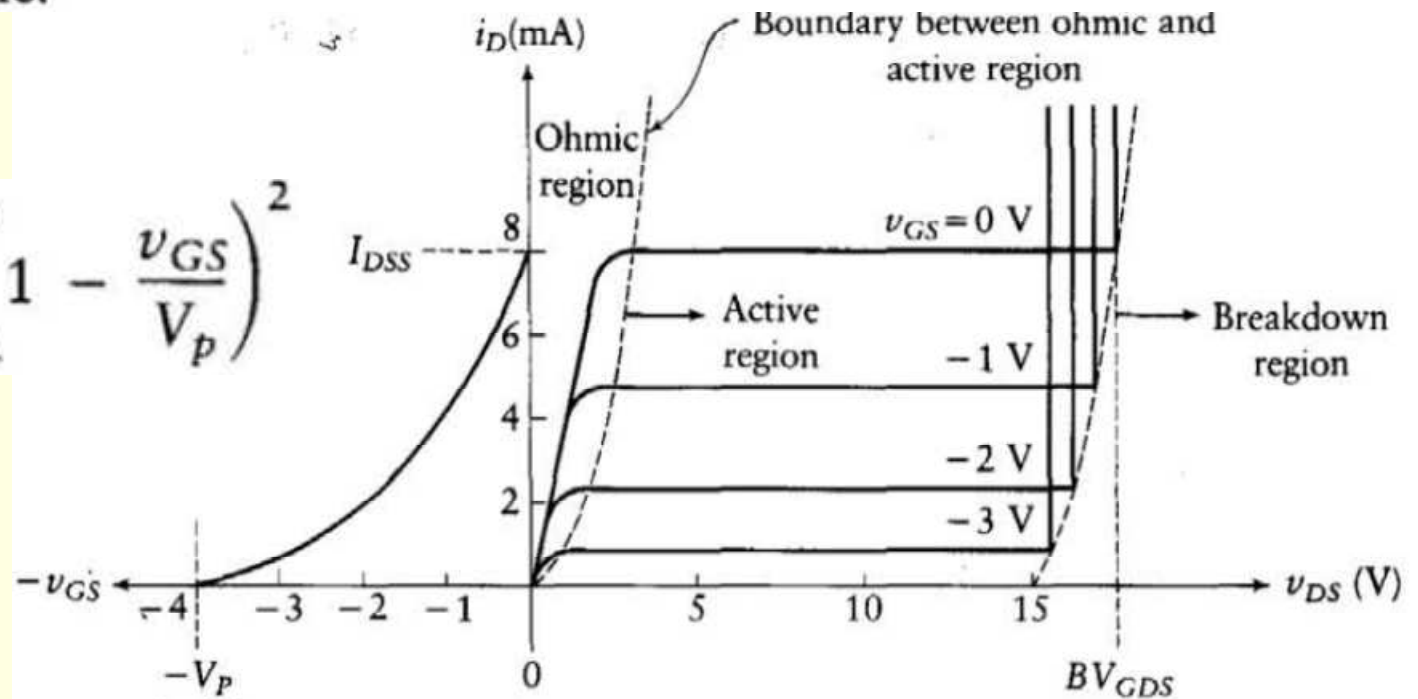

**Figure 4.5**  
JFET characteristics.

(a) Transfer characteristic

(b)  $i_D$ - $v_{DS}$  characteristic



# 4.3.2 JFET Transfer Characteristics

The transfer and  $i_D$ - $v_{GS}$  characteristic curves for the JFET, which are shown in Figure 4.5, are different from the similar curves for a BJT: The FET is a voltage-controlled device, whereas the BJT is a current-controlled device. The controlling parameter for the FET is gate-source voltage rather than base current, as in the BJT.

$$\frac{i_D}{I_{DSS}} \approx \left(1 - \frac{v_{GS}}{V_p}\right)^2$$

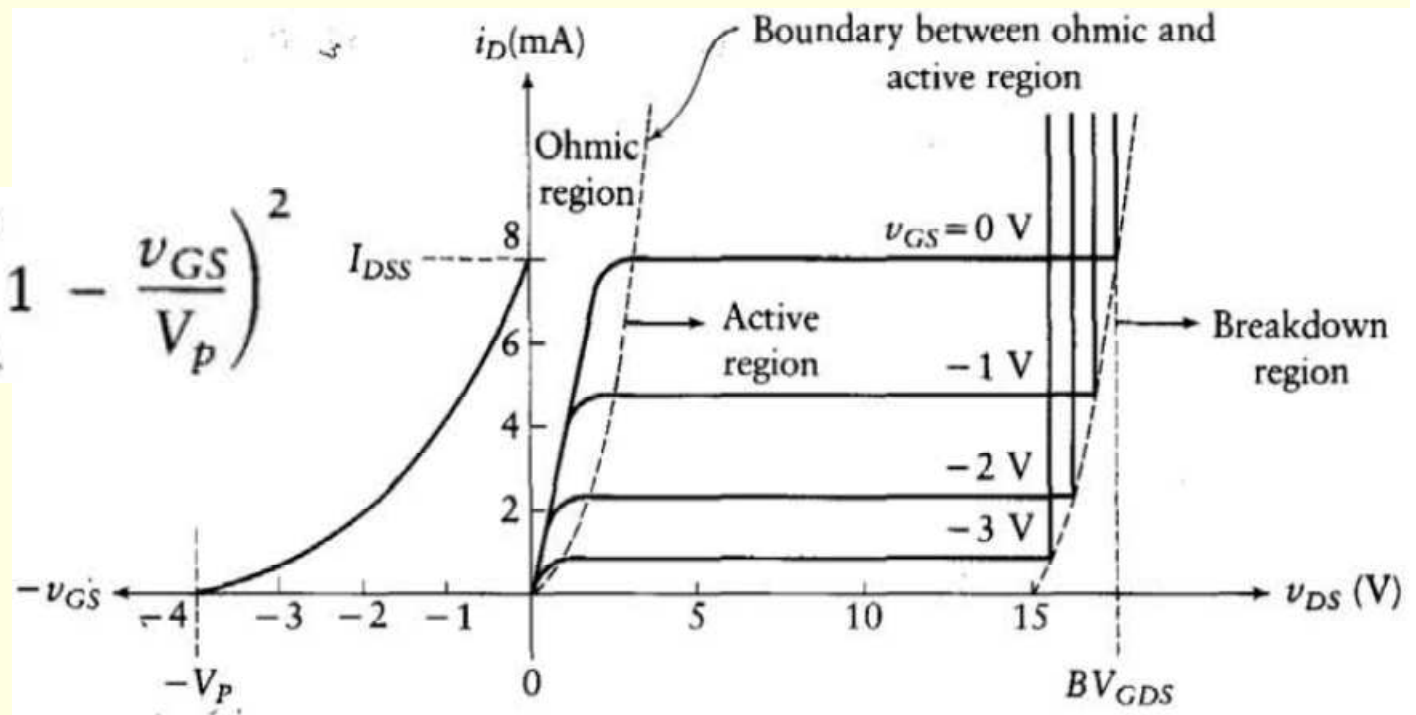

**Figure 4.5**  
JFET characteristics.

(a) Transfer characteristic

(b)  $i_D$ - $v_{GS}$  characteristic

# 4.3.2 JFET Transfer Characteristics

There are two other distinct differences between the FET and BJT. First, the vertical spacing between pairs of parametric curves for the FET is not linearly related to the value of the controlling parameter. Thus, for example, the distance between the  $v_{GS} = 0\text{ V}$  curve and  $v_{GS} = -1\text{ V}$  curve in Figure 4.5 is not the same as that between the  $v_{GS} = -1\text{ V}$  curve and  $v_{GS} = -2\text{ V}$  curve. This contrasts with the BJT curves, where a more linear relationship exists.

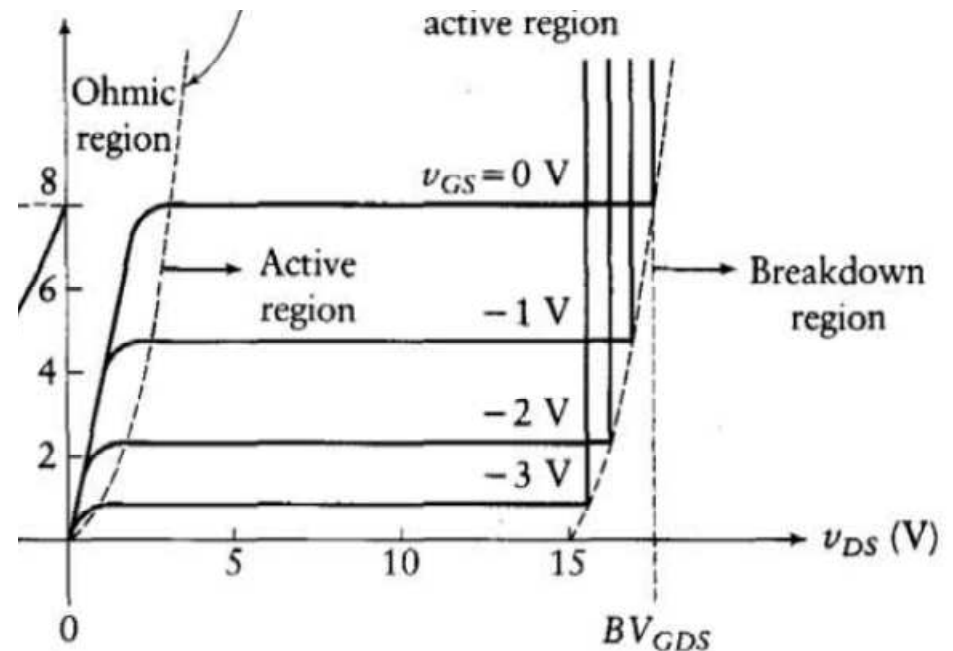
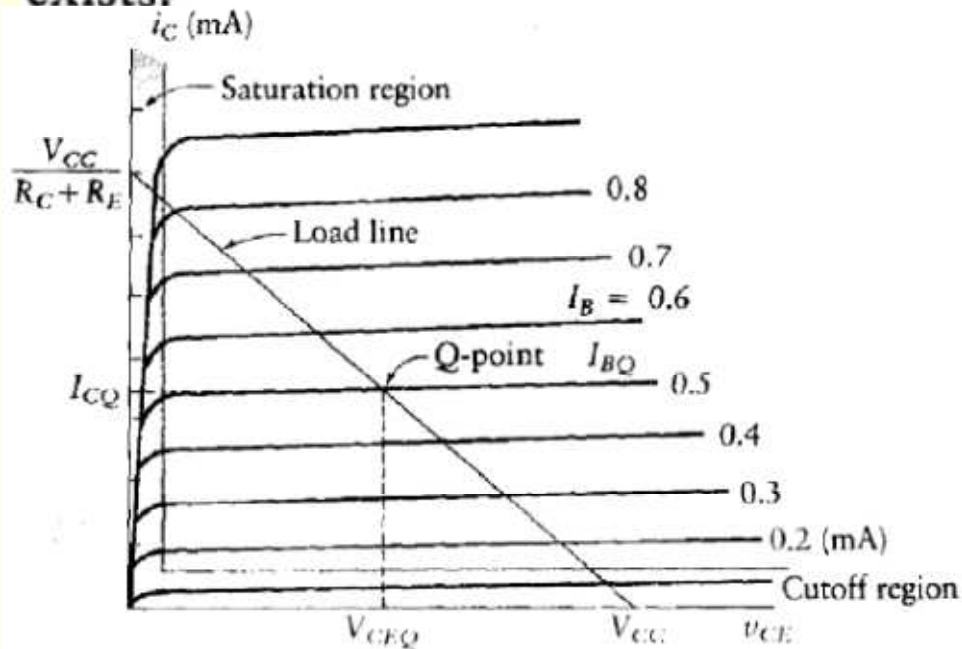

Figure 2.11 Family of transistor characteristic curves.

(b)  $i_D$ - $v_{GS}$  characteristic



## 4.3.2 JFET Transfer Characteristics

The second difference relates to the size and shape of the ohmic region of the characteristic curves. Recall that in using BJTs, we avoid nonlinear operation by not using the transistor at the lower 5% of values of  $v_{CE}$ , which is called the *saturation region*. We see that the width of the ohmic region for the JFET is a function of the gate-to-source voltage. As the magnitude of the gate-to-source voltage decreases, the width of the ohmic region increases. We also note from Figure 4.5 that the breakdown voltage is a function of the gate-to-source voltage.

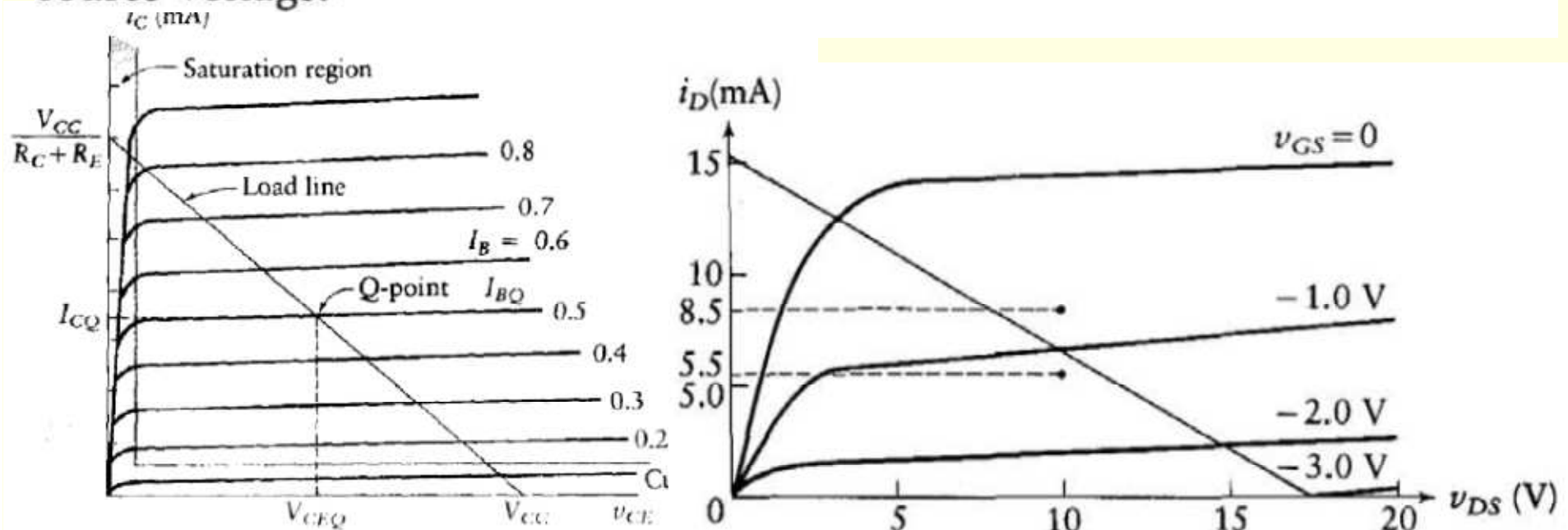
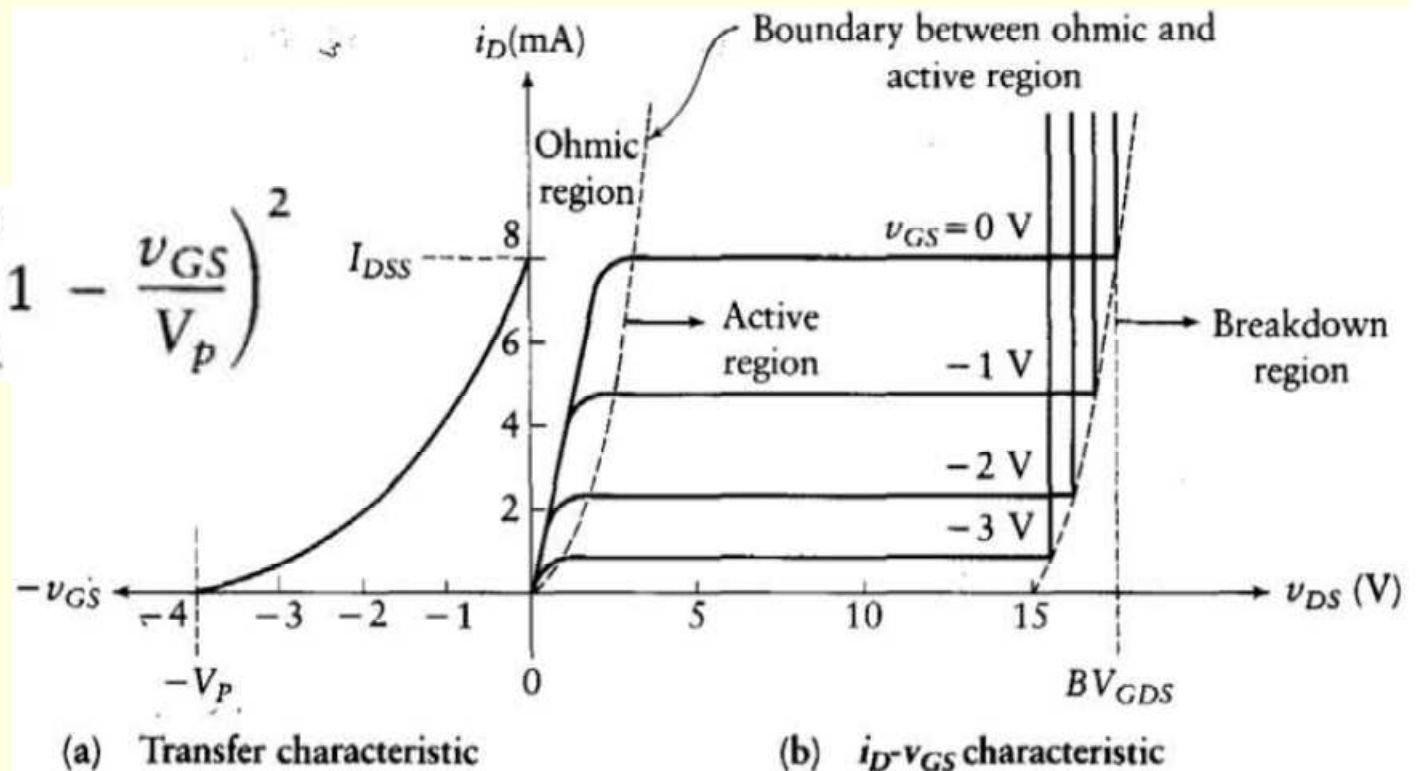

Figure 2.11 Family of transistor characteristic curves.

## 4.3.2 JFET Transfer Characteristics

The region between pinch-off and avalanche breakdown is called the *active region*, *amplifier operating region*, *saturation region*, or *pinch-off region*, as shown in Figure 4.5. The ohmic region (before pinch-off) is sometimes called the *voltage-controlled region*. The FET is operated in this region both when a variable resistor is desired and in switching applications.

$$\frac{i_D}{I_{DSS}} \approx \left(1 - \frac{v_{GS}}{V_p}\right)^2$$



**Figure 4.5**  
JFET characteristics.

(a) Transfer characteristic

(b)  $i_D$ - $v_{DS}$  characteristic

## 4.3.2 JFET Transfer Characteristics

The breakdown voltage is a function of  $v_{GS}$  as well as  $v_{DS}$ . As the magnitude of the voltage between gate and source is increased (more negative for  $n$ -channel and more positive for  $p$ -channel), the breakdown voltage decreases. With  $v_{GS} = V_p$ , the drain current is zero (except for a small leakage current), and with  $v_{GS} = 0$ , the drain current saturates at a value

$$i_D = I_{DSS}$$

where  $I_{DSS}$  is the *saturation drain-to-source current*.

$$\frac{i_D}{I_{DSS}} \approx \left(1 - \frac{v_{GS}}{V_p}\right)^2$$

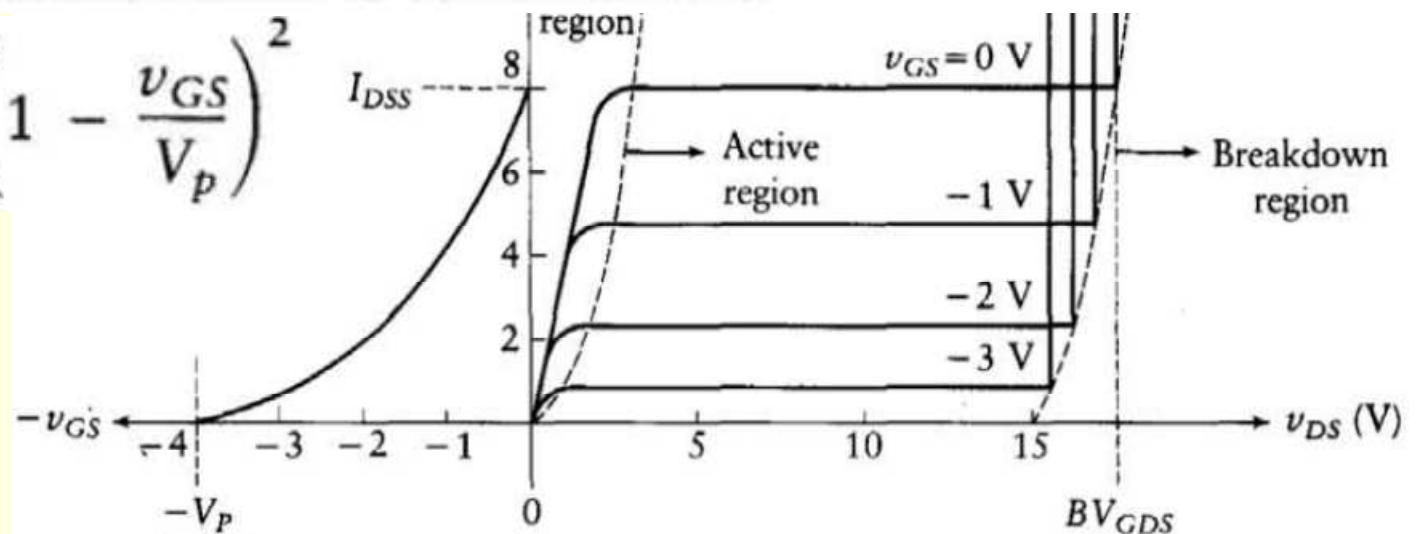

**Figure 4.5**  
JFET characteristics.

(a) Transfer characteristic

(b)  $i_D$ - $v_{GS}$  characteristic

## 4.3.2 JFET Transfer Characteristics

Between pinch-off and breakdown, the drain current is saturated and does not change appreciably as a function of  $v_{DS}$ . After the FET passes the pinch-off operating point, the value of  $i_D$  can be obtained from the characteristic curves or from equation (4.1), which is repeated here for reference.

$$\frac{i_D}{I_{DSS}} \approx \left(1 - \frac{v_{GS}}{V_p}\right)^2$$

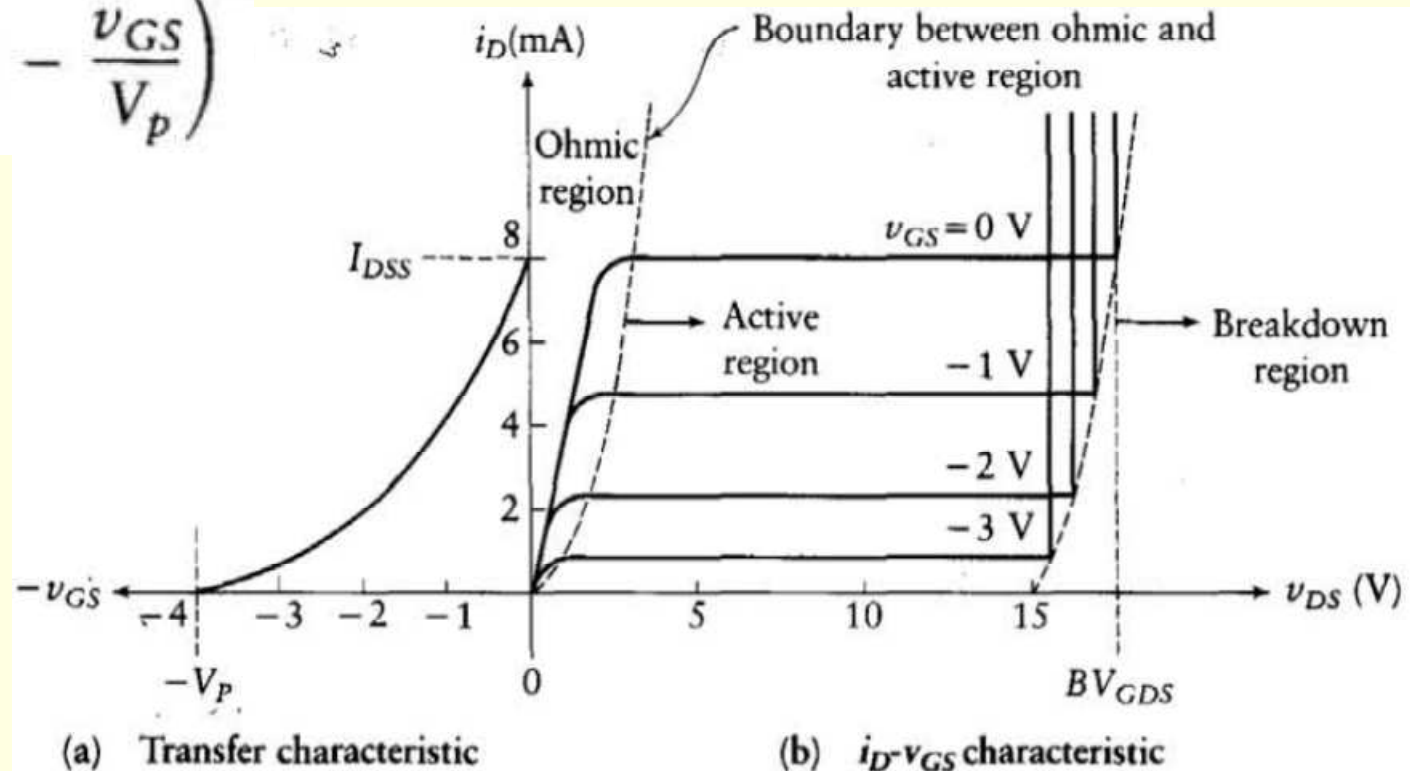

**Figure 4.5**  
JFET characteristics.



## 4.3.2 JFET Transfer Characteristics

The saturation drain-to-source current,  $I_{DSS}$ , is a function of temperature,

$$I_{DSS} = KT^{-3/2}$$

where  $K$  is a constant [51]. The pinch-off voltage is an approximately linear function of temperature (as is the case with the base-emitter current in the BJT); hence

$$\Delta V_p = -k_p \Delta T$$

where  $k_p \approx 2 \text{ mV}/^\circ\text{C}$ .

The currents and voltages in this section are presented for an  $n$ -channel JFET. The values for a  $p$ -channel JFET are the reverse of those just given for the  $n$ -channel.

## 4.3.3 Equivalent Circuit, $g_m$ and $r_{DS}$

In order to obtain a measure of the amplification possible with a JFET, we introduce the parameter  $g_m$ , which is the *forward transconductance*. This parameter is similar to the current gain (or  $h_{fe}$ ) for a BJT. The value of  $g_m$ , which is measured in siemens (S), is a measure of the change in drain current for a change in gate-source voltage. This can be expressed as

$$g_m = \frac{\partial i_D}{\partial v_{GS}} \approx \frac{\Delta i_D}{\Delta v_{GS}} \Bigg|_{V_{DS} = \text{constant}} \quad (4.2)$$

The transconductance,  $g_m$ , does not remain constant as the Q-point is changed. This can be seen by geometrically determining  $g_m$  from the transfer characteristic curves. As  $i_D$  changes, the slope of the transfer characteristic curve of Figure 4.5 varies, thereby changing  $g_m$ .



## 4.3.3 Equivalent Circuit, $g_m$ and $r_{DS}$

The transconductance,  $g_m$ , does not remain constant as the Q-point is changed. This can be seen by geometrically determining  $g_m$  from the transfer characteristic curves. As  $i_D$  changes, the slope of the transfer characteristic curve of Figure 4.5 varies, thereby changing  $g_m$ .

We can find the transconductance by differentiating equation (4.1), with the result

$$g_m = \frac{\partial i_D}{\partial v_{GS}} = \frac{2I_{DSS}(1 - v_{GS}/V_p)}{-V_p} \quad (4.3)$$

We define

$$g_{m0} = \frac{2I_{DSS}}{-V_p}$$

which is the transconductance at  $v_{GS} = 0$ .

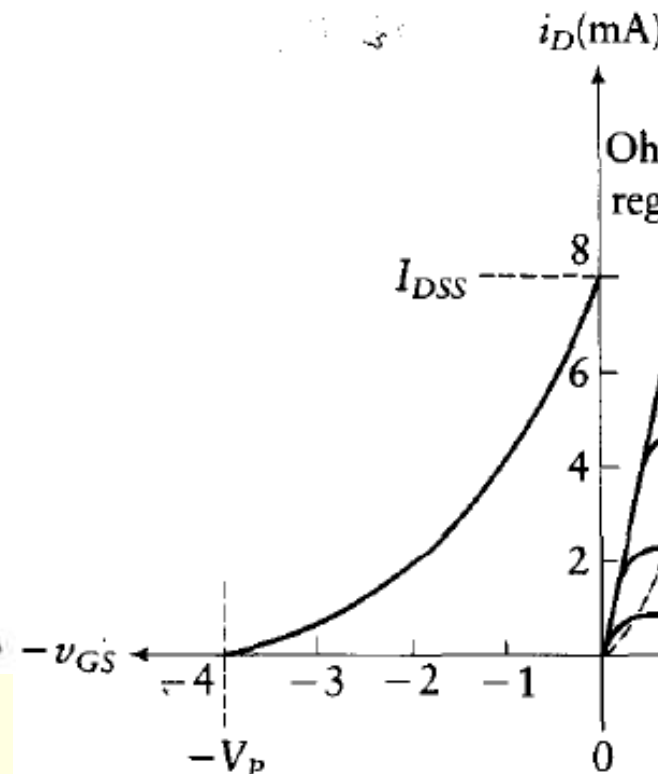

(a) Transfer characteristic

## 4.3.3 Equivalent Circuit, $g_m$ and $r_{DS}$

which is the transconductance at  $v_{GS} = 0$ . Using this equation, the transconductance is given by

$$g_m = g_{mo} \left( 1 - \frac{v_{GS}}{V_p} \right) \quad (4.4)$$

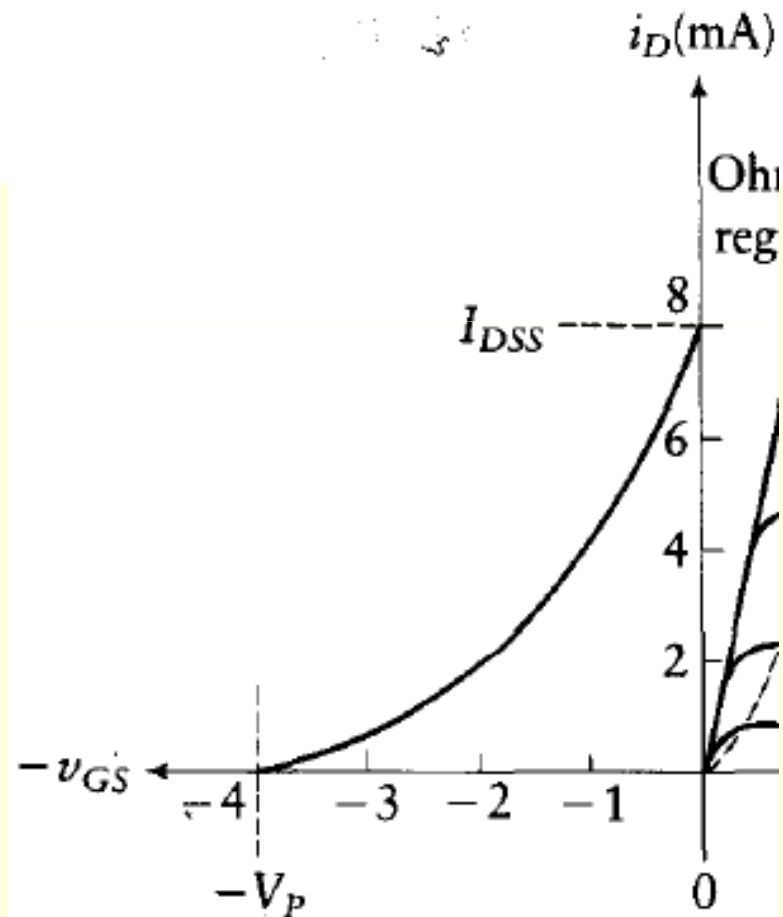

(a) Transfer characteristic

## 4.3.3 Equivalent Circuit, $g_m$ and $r_{DS}$

An alternate form of equation (4.4) can be found by defining

$$k_n = \frac{I_{DSS}}{V_p^2}$$

in equation (4.1), and rearranging terms, as follows:

$$i_D = I_{DSS} \left( 1 - \frac{v_{GS}}{V_p} \right)^2 = \frac{I_{DSS}}{V_p^2} (V_p - v_{GS})^2 = k_n (V_p - v_{GS})^2$$

We select the Q-point so  $i_D = I_{DQ}$  and  $v_{GS} = V_{GSQ}$ . Thus we obtain

$$V_p - V_{GSQ} = - \sqrt{\frac{I_{DQ}}{k_n}} \quad (4.5)$$

## 4.3.3 Equivalent Circuit, $g_m$ and $r_{DS}$

But from equation (4.3),

$$g_m = -\frac{2I_{DSS}}{V_p} \left(1 - \frac{V_{GSQ}}{V_p}\right) = -\frac{2I_{DSS}}{V_p^2} (V_p - V_{GSQ})$$

We use equation (4.5) and substitute for  $V_p - V_{GSQ}$  to obtain

$$g_m = \frac{2I_{DSS}}{V_p^2} \sqrt{\frac{I_{DQ}}{k_n}} = 2k_n \sqrt{\frac{I_{DQ}}{k_n}} = 2\sqrt{k_n I_{DQ}} \quad (4.6)$$



## 4.3.3 Equivalent Circuit, $g_m$ and $r_{DS}$

The *inverse dynamic resistance*,  $r_{DS}$ , is defined as the inverse of the slope of the  $i_D$ - $v_{DS}$  curve in the saturated region:

$$\frac{1}{r_{DS}} = \frac{\partial i_D}{\partial v_{DS}} \approx \frac{\Delta i_D}{\Delta v_{DS}} \Bigg|_{\Delta v_{GS} = \text{constant}} \quad (4.7)$$

Because the slope of this curve is so small in the active region (see Figure 4.4),  $r_{DS}$  is large.

We develop the ac equivalent circuit for a JFET much as we did for the BJT, with the expression

$$\Delta i_D = \frac{\partial i_D}{\partial v_{GS}} \Delta v_{GS} + \frac{\partial i_D}{\partial v_{DS}} \Delta v_{DS}$$

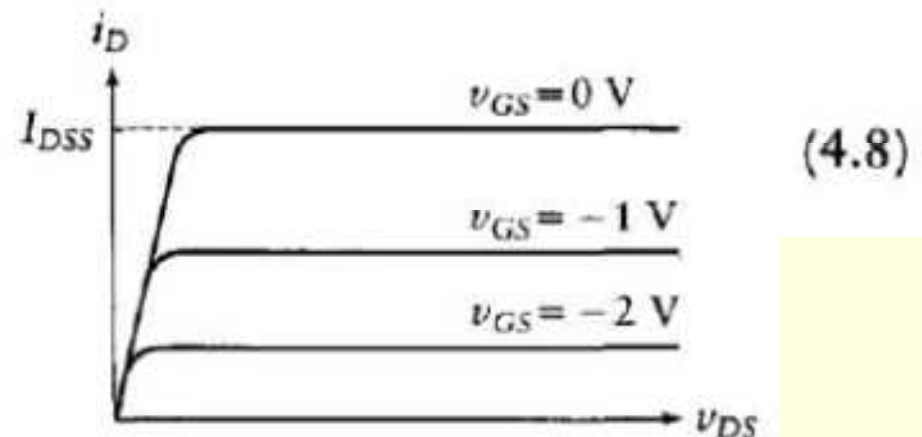

## 4.3.3 Equivalent Circuit, $g_m$ and $r_{DS}$

which leads to the equivalent circuit shown in Figure 4.6(a). Because  $r_{DS}$  is so large, we can usually use the simplified equivalent circuit of Figure 4.6(b) to determine the active region performance of a JFET. Equation (4.9) then reduces to

$$\Delta i_D = g_m \Delta v_{GS}$$

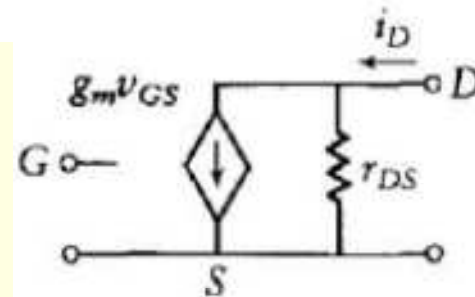

(a) Including  $r_{DS}$

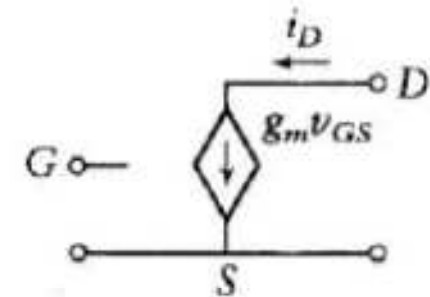

(b) Simplified

The performance of a JFET is specified by the values of  $g_m$  and  $r_{DS}$ . We now determine these parameters for an  $n$ -channel JFET using the characteristic curve shown in Figure 4.7. We select an operating region that is approximately in the middle of the curves, that is, between  $v_{GS} = -0.8$  V and  $v_{GS} = -1.2$  V and  $i_D = 8.5$  mA and  $i_D = 5.5$  mA. From equation (4.2), we find

## 4.3.3 Equivalent Circuit, $g_m$ and $r_{DS}$

The performance of a JFET is specified by the values of  $g_m$  and  $r_{DS}$ . We now determine these parameters for an  $n$ -channel JFET using the characteristic curve shown in Figure 4.7. We select an operating region that is approximately in the middle of the curves, that is, between  $v_{GS} = -0.8$  V and  $v_{GS} = -1.2$  V and  $i_D = 8.5$  mA and  $i_D = 5.5$  mA. From equation (4.2), we find

$$g_m = \left. \frac{\Delta i_D}{\Delta v_{GS}} \right|_{v_{DS} = \text{constant}} = \frac{(5.5 - 8.5) \text{ mA}}{-1.2 - (-0.8)} = 7.5 \text{ mS}$$

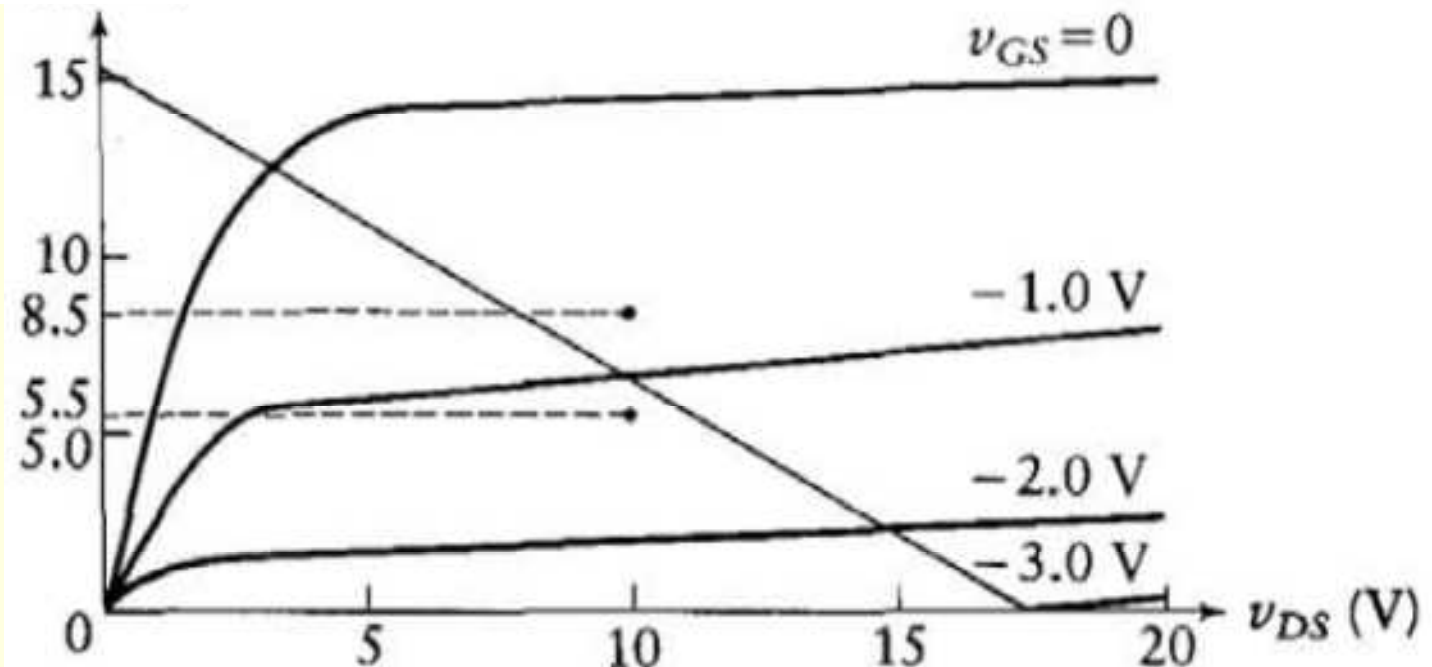

## 4.3.3 Equivalent Circuit, $g_m$ and $r_{DS}$

If the characteristic curves for a JFET are not available,  $g_m$  and  $v_{GS}$  can be obtained mathematically, provided  $I_{DSS}$  and  $V_p$  are known. These two parameters are usually given in the manufacturer's specifications. The quiescent drain current,  $I_{DQ}$ , can be selected to be between 0.3 and 0.7 times  $I_{DSS}$ , which locates the Q-point in the most linear region of the characteristic curves. Repeating equation (4.1), we have

$$i_D = I_{DSS} \left( 1 - \frac{v_{GS}}{V_p} \right)^2$$

and at the quiescent point,

$$g_m = g_{mo} \left( 1 - \frac{V_{GSQ}}{V_p} \right)$$

where

$$g_{mo} = \frac{-2I_{DSS}}{V_p}$$

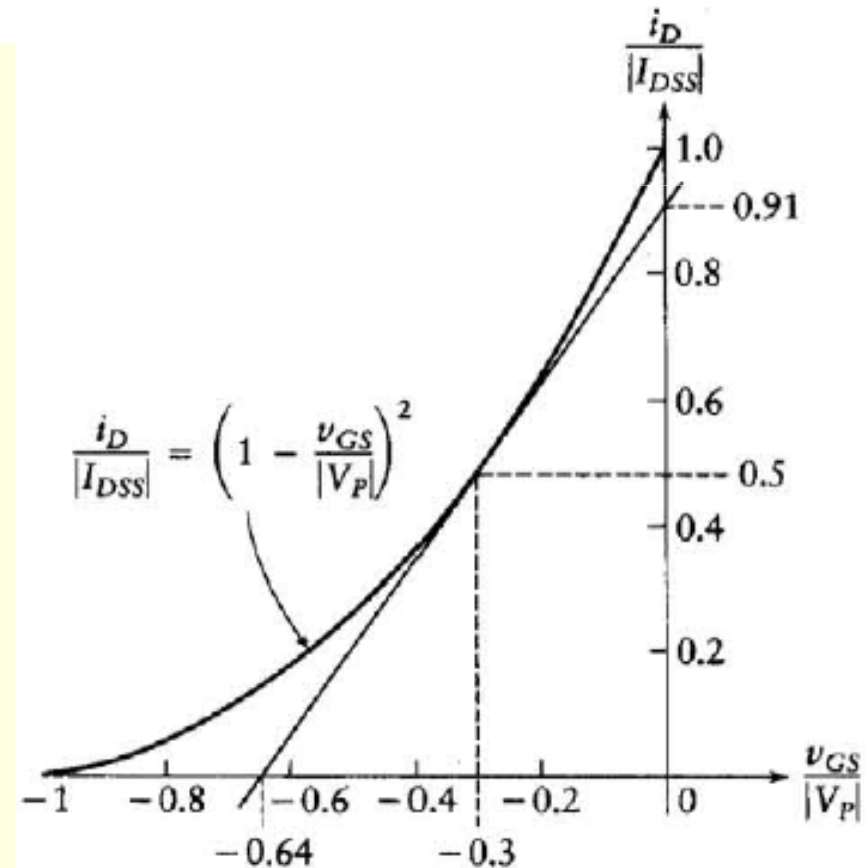



## 4.3.3 Equivalent Circuit, $g_m$ and $r_{DS}$

The relationship between  $i_D$  and  $v_{GS}$  can be plotted on a dimensionless graph (i.e., a normalized curve), as shown in Figure 4.8. The vertical axis of this graph is  $i_D/|I_{DSS}|$ , and the horizontal axis is  $v_{GS}/|V_P|$ . The slope of the curve is  $g_m$ .

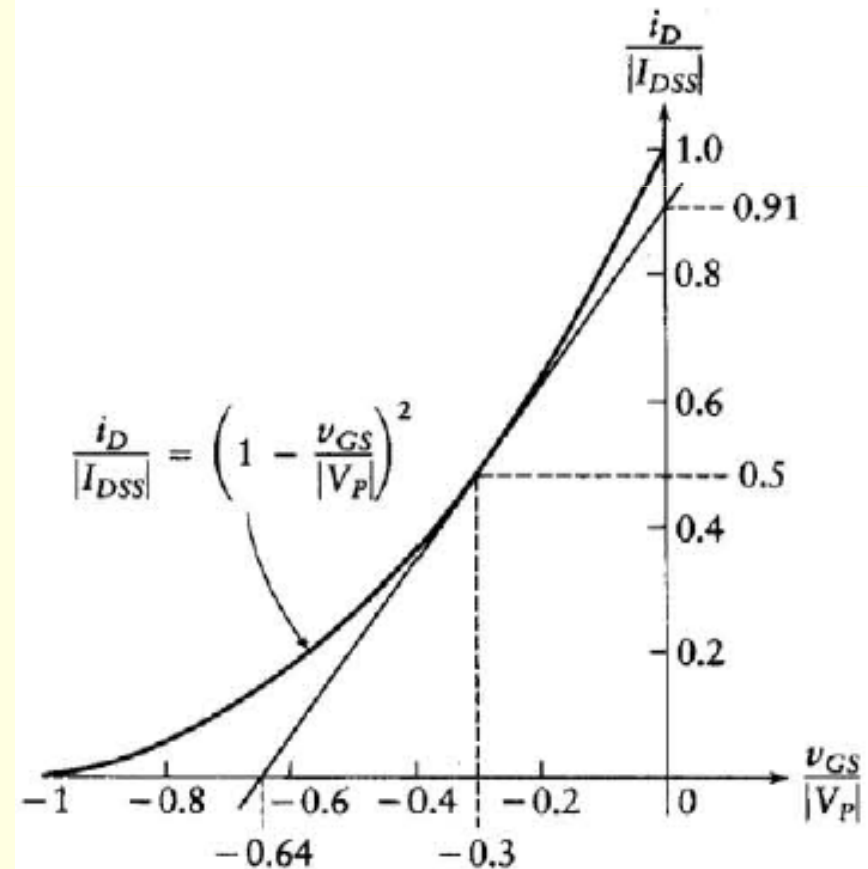

## 4.3.3 Equivalent Circuit, $g_m$ and $r_{DS}$

A reasonable procedure for locating the quiescent value near the center of the linear operating region is as follows:

1. Select  $I_{DQ} = I_{DSS}/2$  and, from the curve,  $V_{GSQ} = 0.3V_p$ . Note from Figure 4.8 that this is near the midpoint of the curve.
2. Select  $V_{DSQ} = V_{DD}/2$ .

We find the transconductance at the Q-point from the slope of the curve of Figure 4.8. This is given by

$$g_m = \frac{0.91I_{DSS}}{0.64V_p} = \frac{1.42 I_{DSS}}{V_p} = -0.71g_{mo}$$

These values usually represent a good starting point for setting the quiescent values for the JFET.